

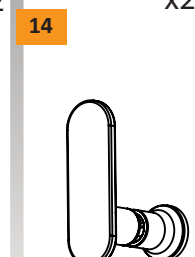

NEW SOLEO

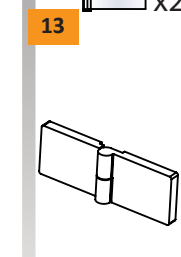

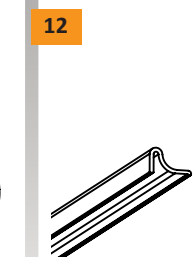
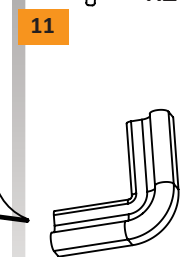
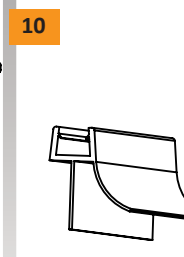
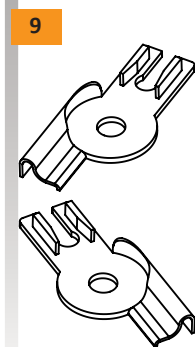
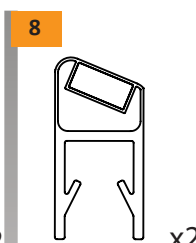
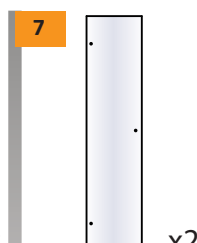
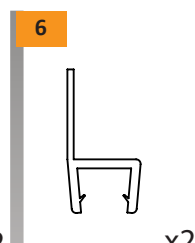
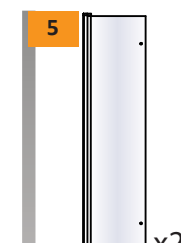
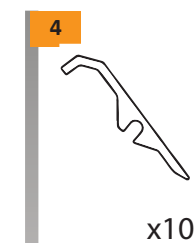
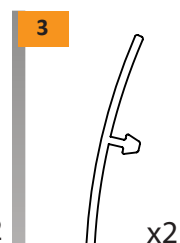
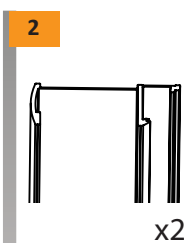
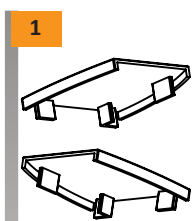
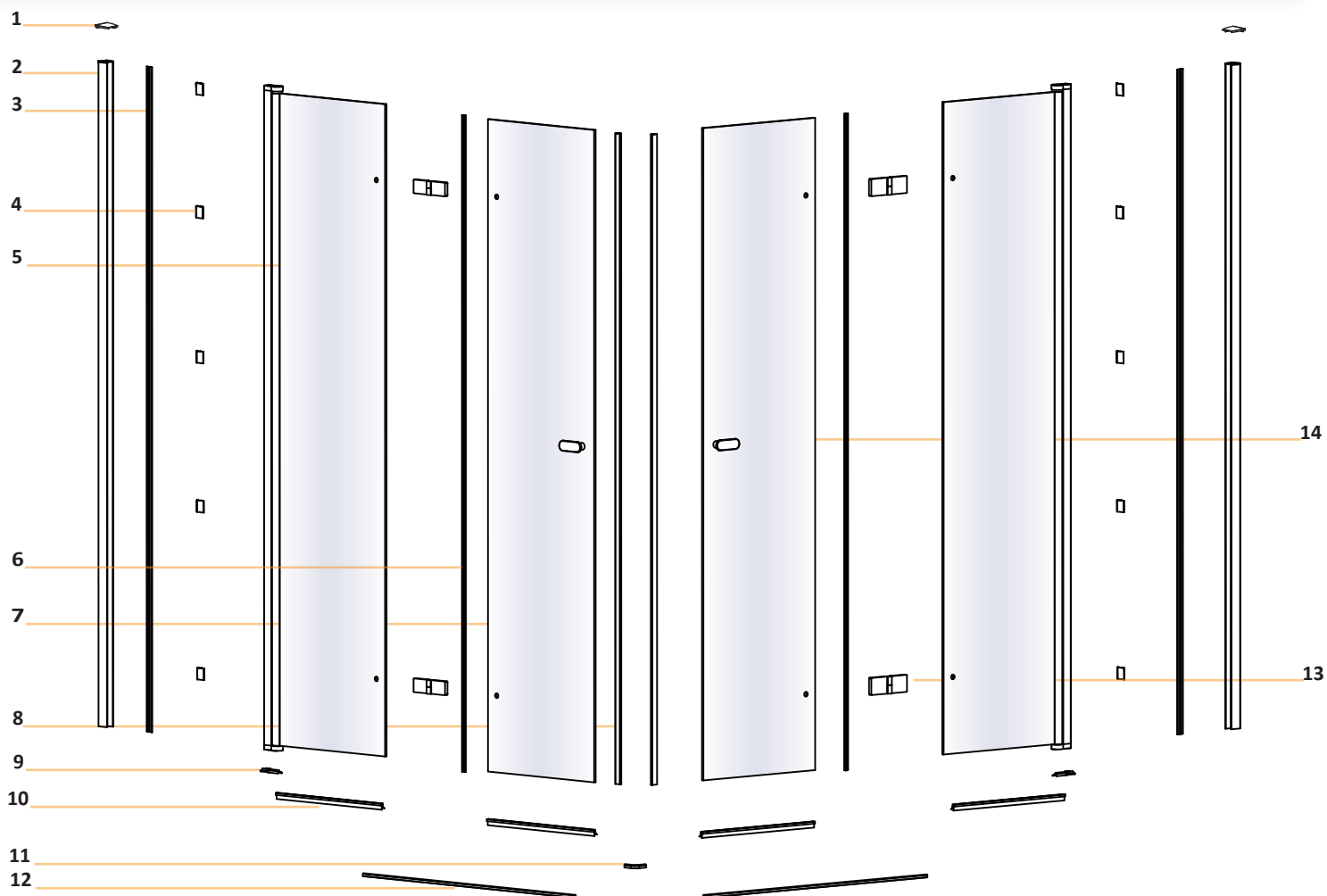
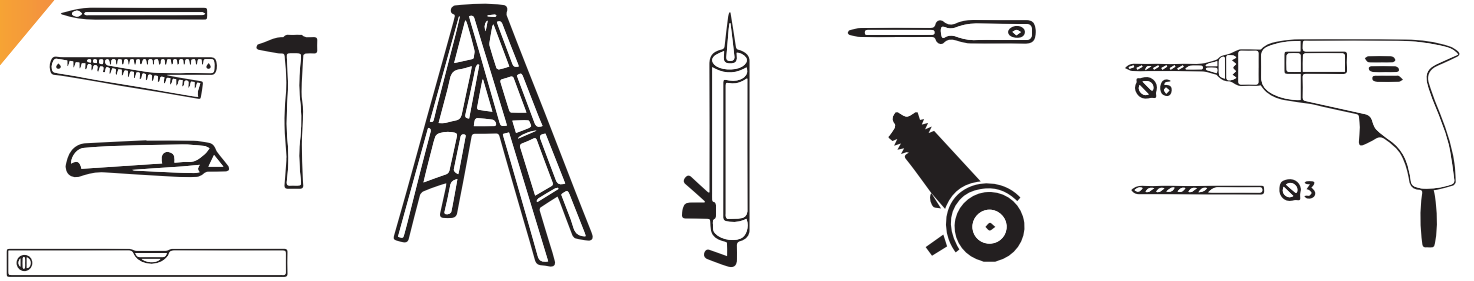

1

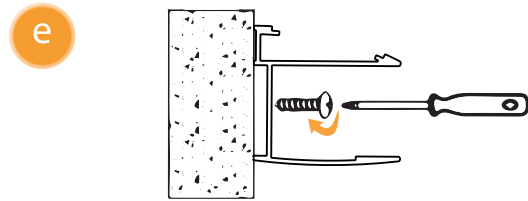
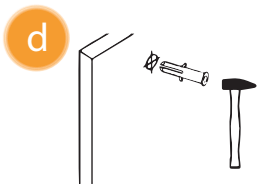
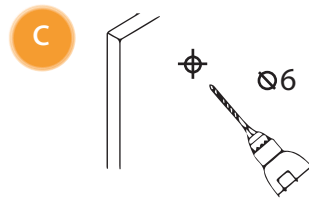
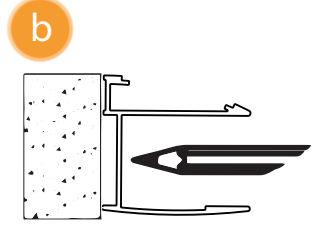
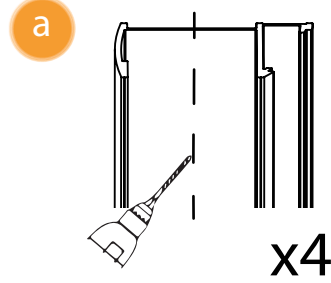
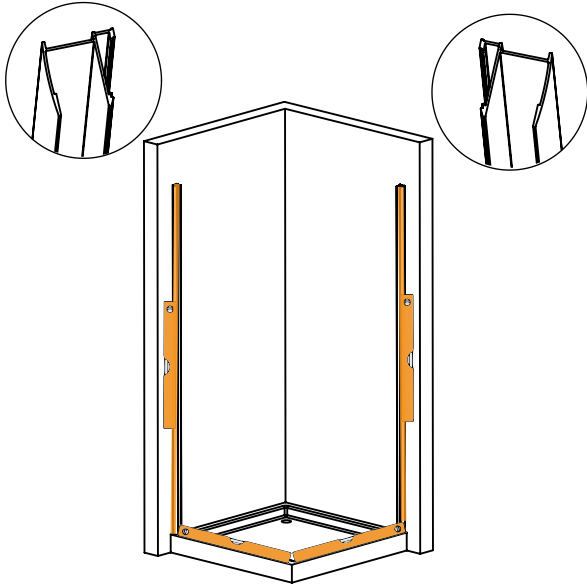

2

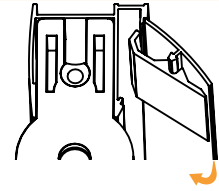
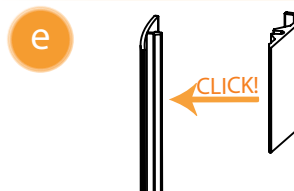
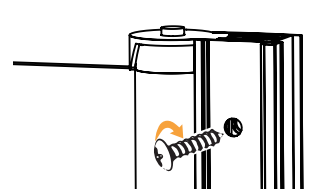
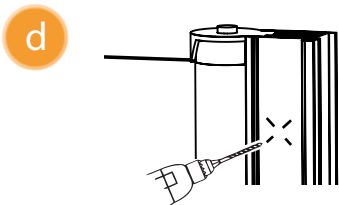
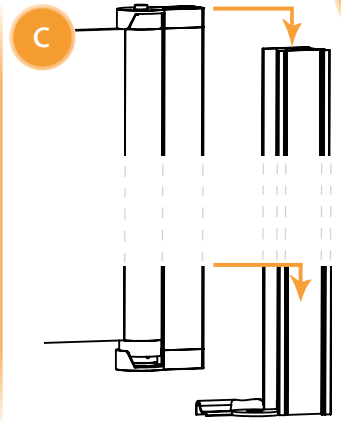
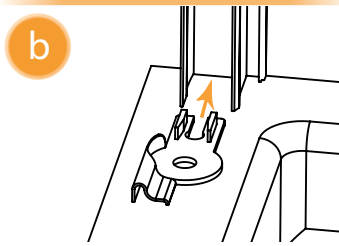
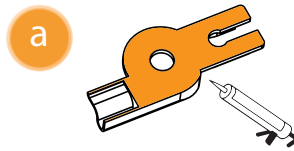
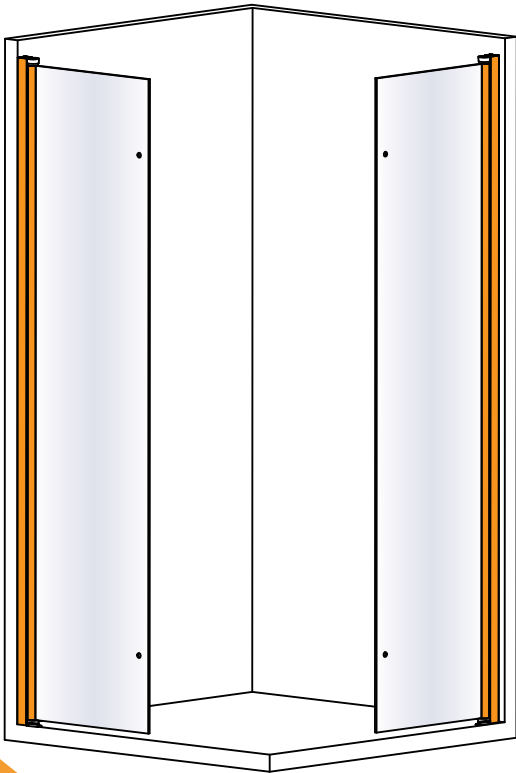

2

3

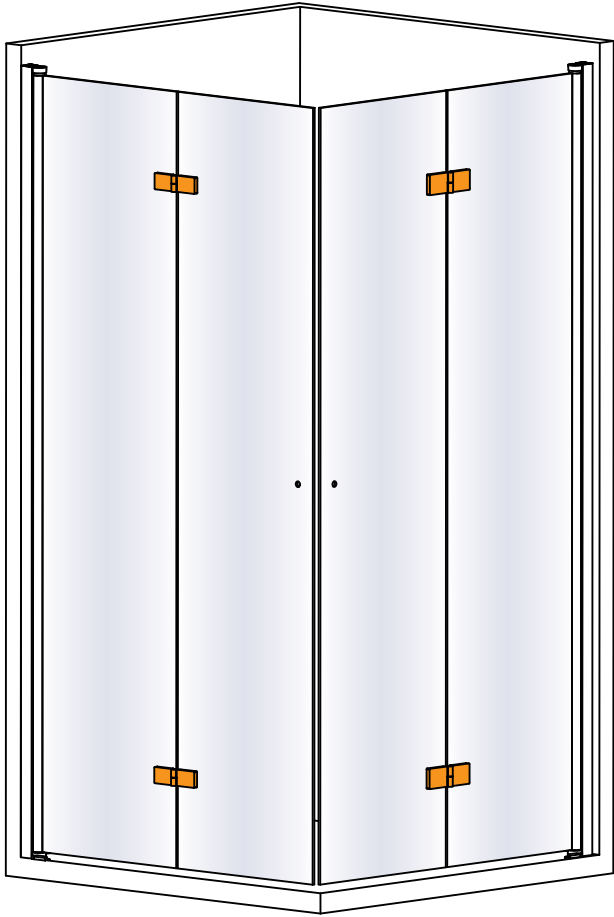

a

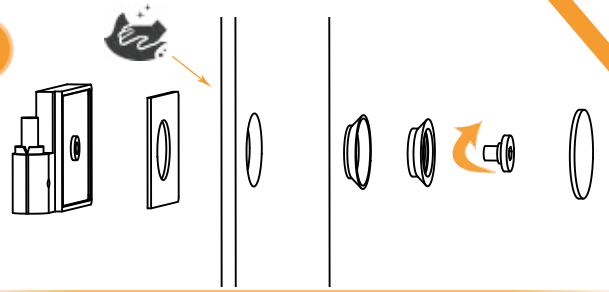

b

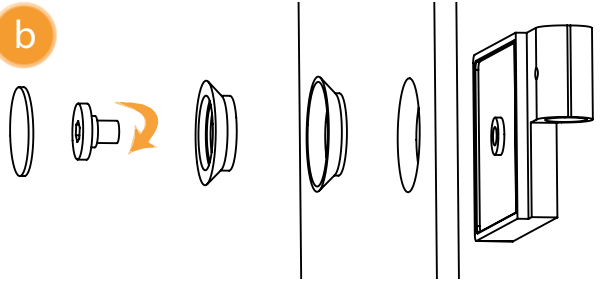

c

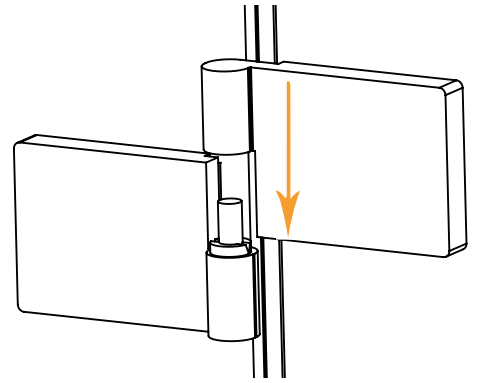

4

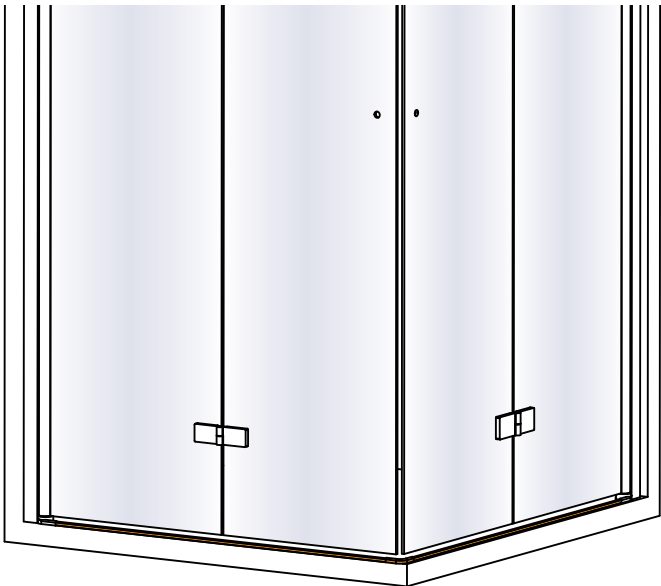

a

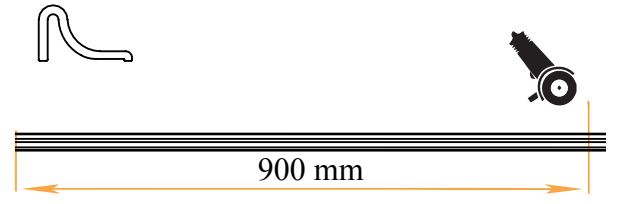

b

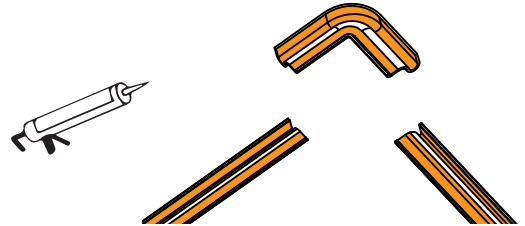

c

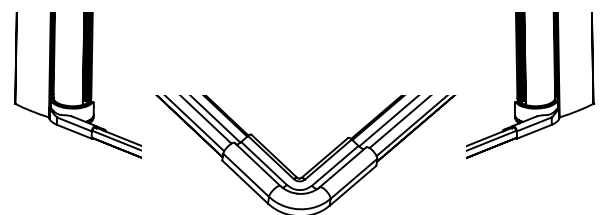

3

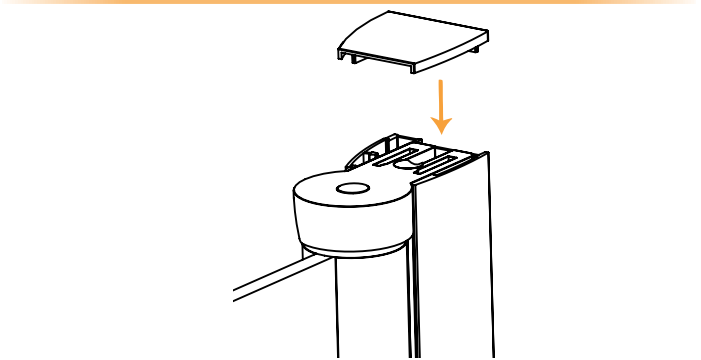
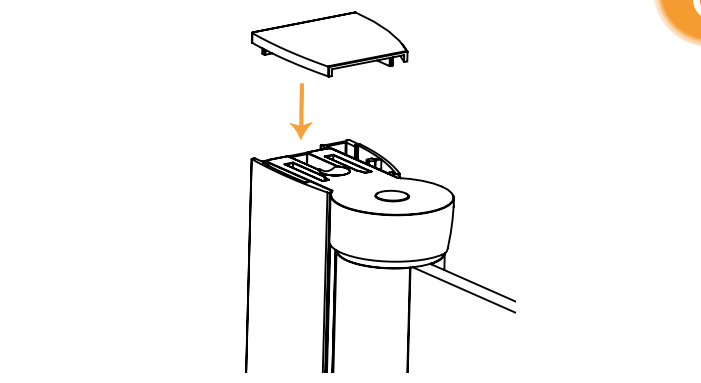
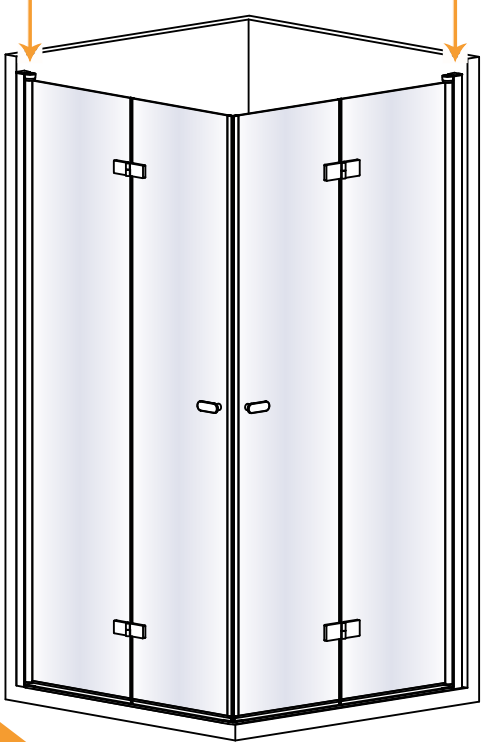
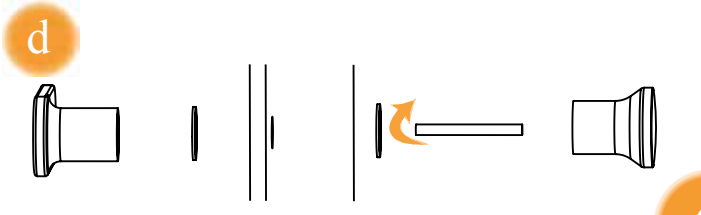
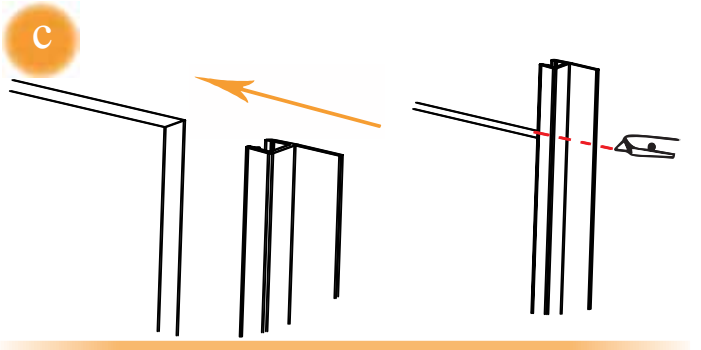
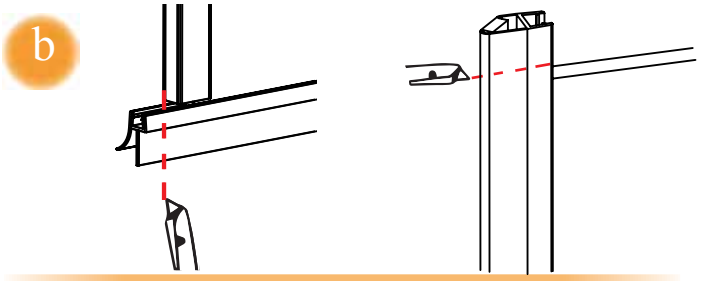
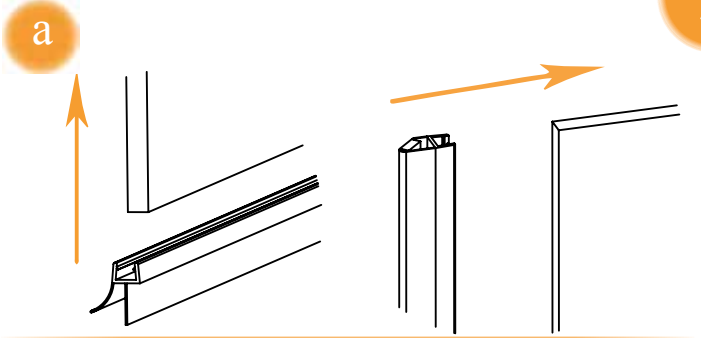
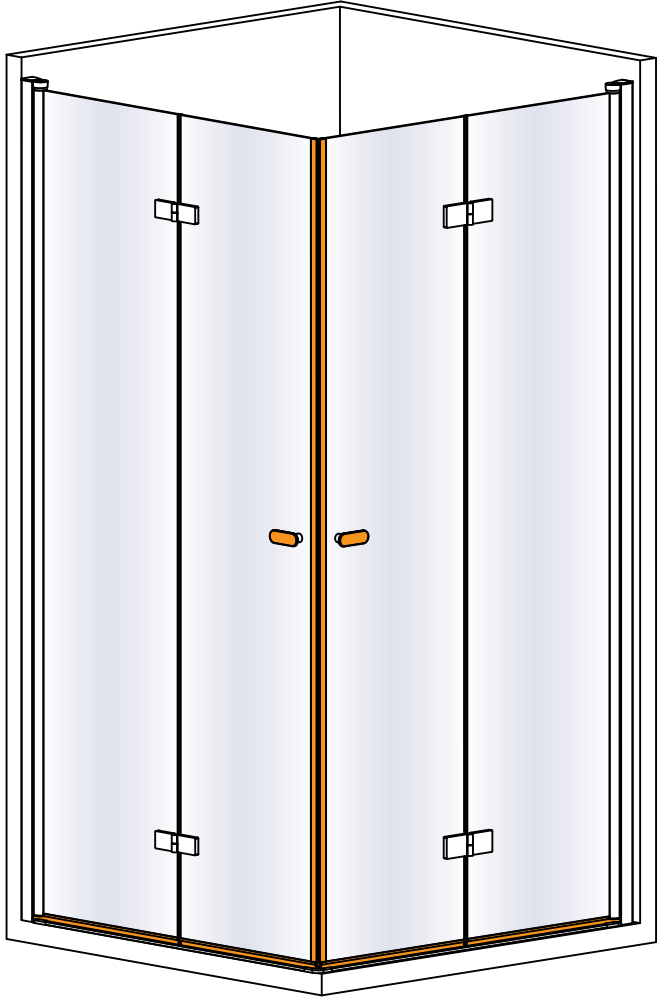



24H

