

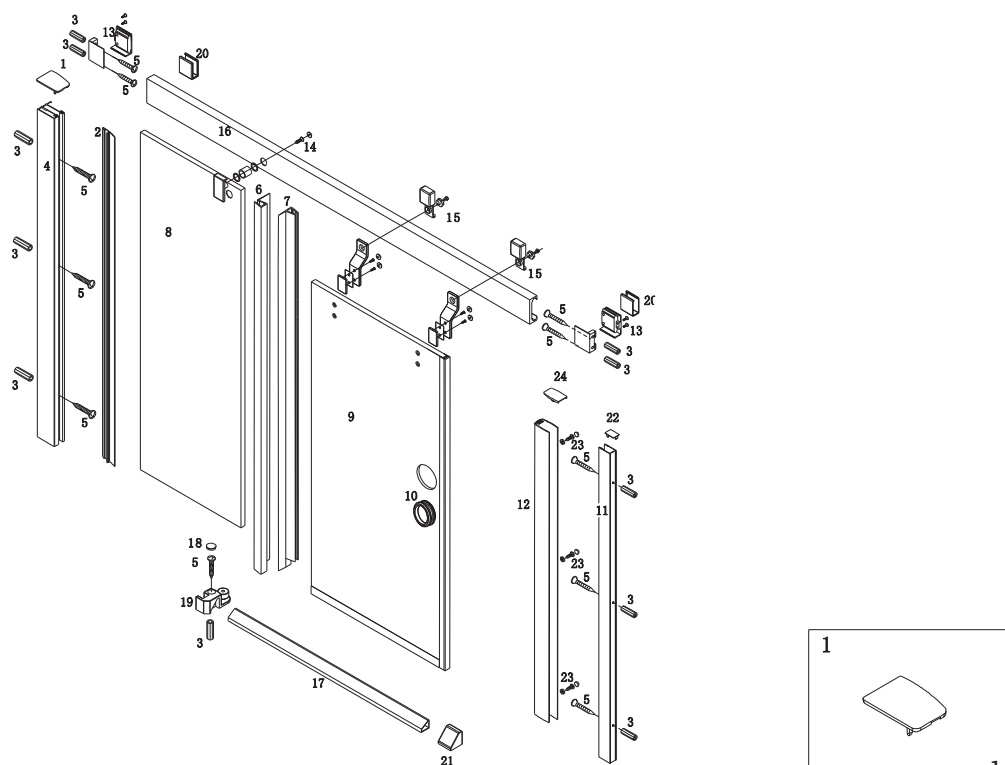















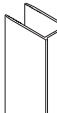
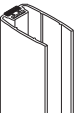
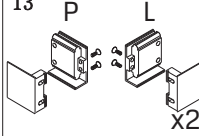
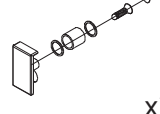
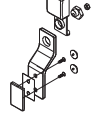
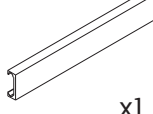

INSTRUKCJA MONTAŻU DRZWI PRYSZNICOWYCH PORTA

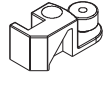
Przed przystąpieniem do montażu przeczytaj uważnie instrukcję oraz sprawdź zestaw pod kątem kompletności i ewentualnych uszkodzeń. W razie problemów prosimy skontaktować się ze sprzedawcą.

LISTA CZĘŚCI

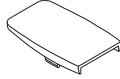

2	3	4	5	6	7
			ST4X30 		
x1	x11	x1	x11	x1	x1
8	9	10	11	12	13
					
x1	x1	x1	x1	x1	x2
14	15	16	17	18	19
					
x1	x2	x1	x1	x1	x1
	21	22	23	24	25
					
x2	x1	x1	x3	x1	x1

