

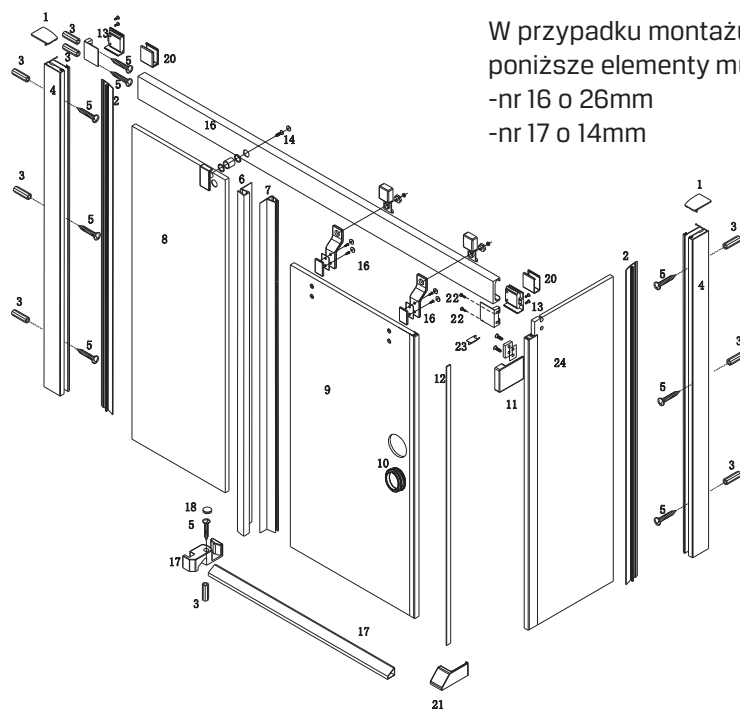

















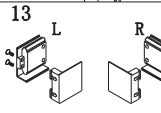
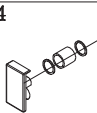
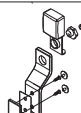
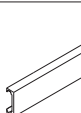
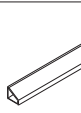

## INSTRUKCJA MONTAŻU KABINY PRYSZNICOWEJ PORTA

Przed przystąpieniem do montażu przeczytaj uważnie instrukcję oraz sprawdź zestaw pod kątem kompletności i ewentualnych uszkodzeń. W razie problemów prosimy skontaktować się ze sprzedawcą.

### LISTA CZĘŚCI



W przypadku montażu kabiny prostokątnej,  
poniższe elementy muszą zostać skrócone:  
-nr 16 o 26mm  
-nr 17 o 14mm

1  x2	2  x2	3  x9	4  x2	5 <b>ST4X30</b>  x9	6  x1
7  x1	8  x1	9  x1	10  x1	11  x1	12  x1
13  x2	14  x1	15  x2	16  x1	17  x1	18  x1
19  x1	20  x2	21  x1	22 <b>M4X20</b>  x2	23  x1	24  x1

