

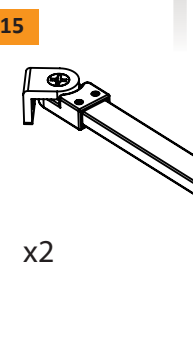

## NEW SOLEO

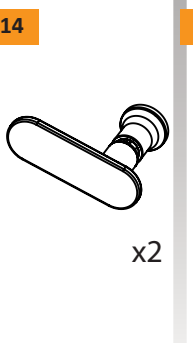

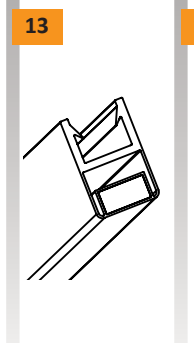
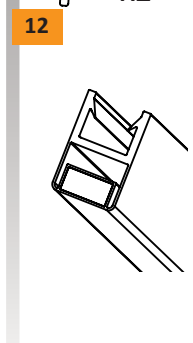
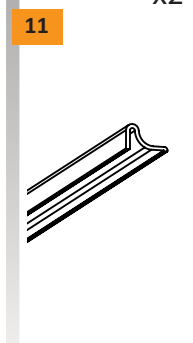
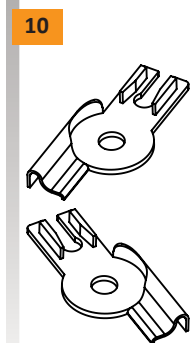
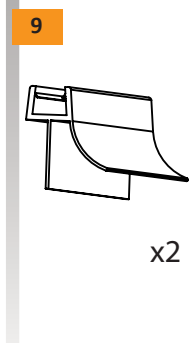
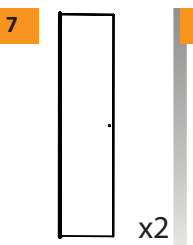
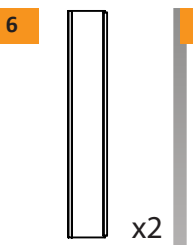
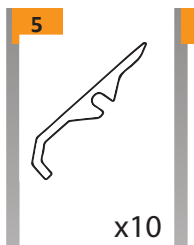
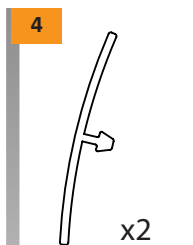
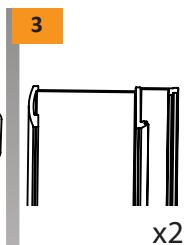
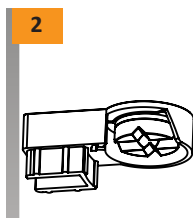
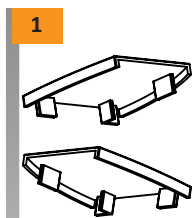
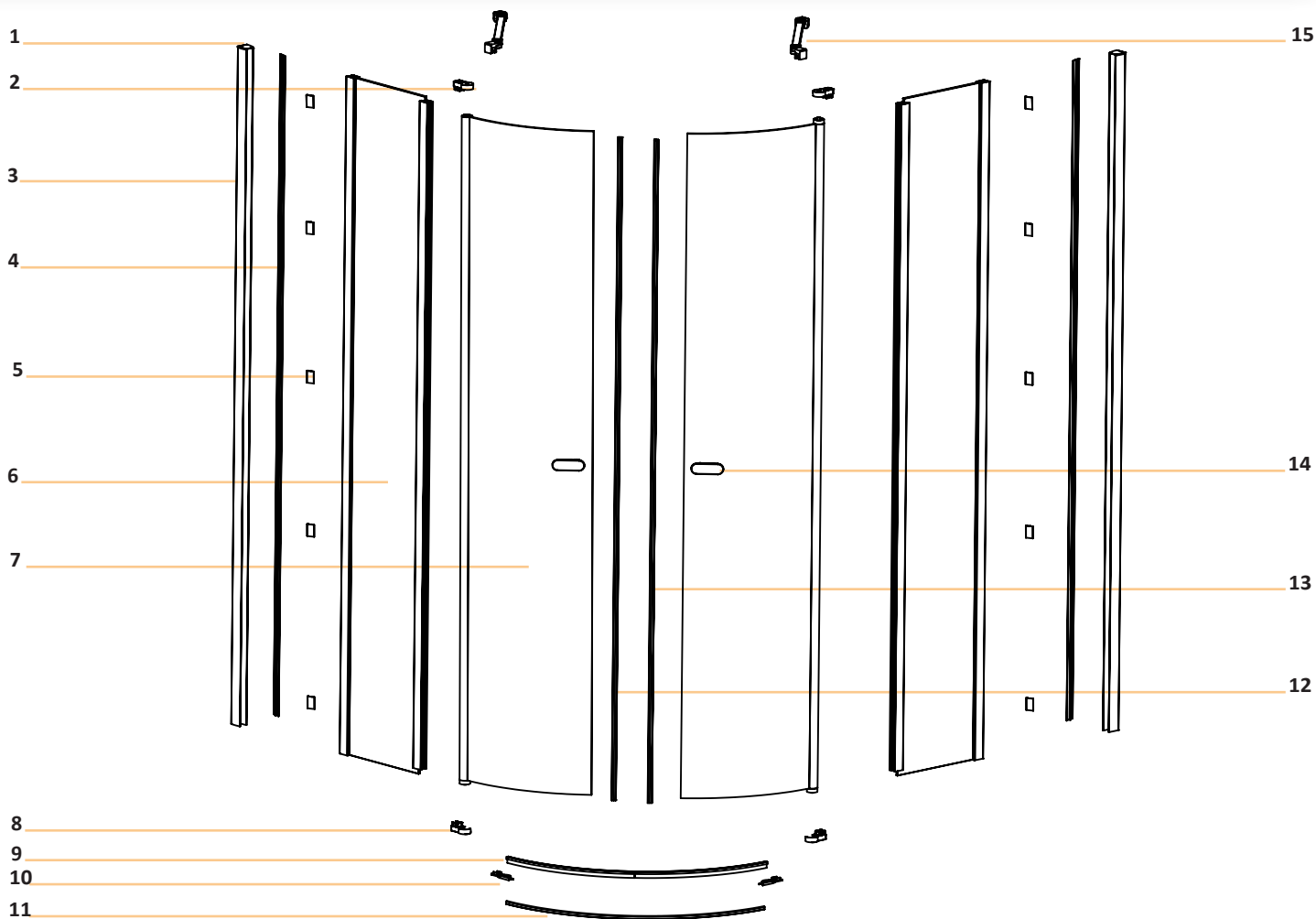
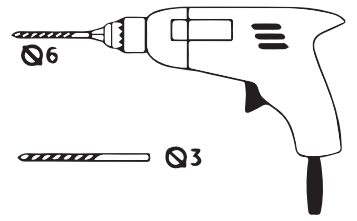
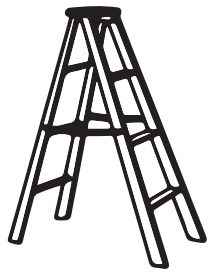
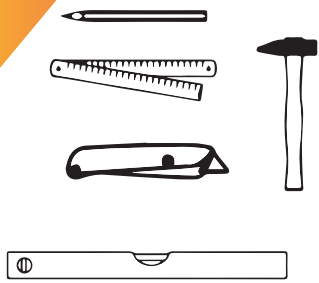

1

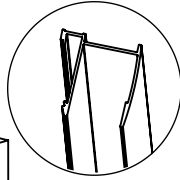
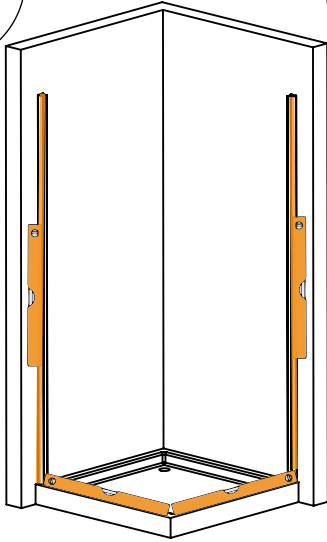
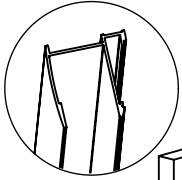

a

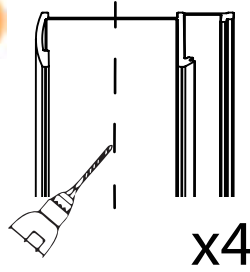

b

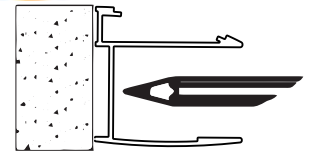

c

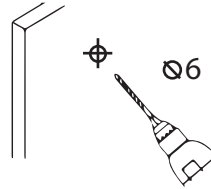

d

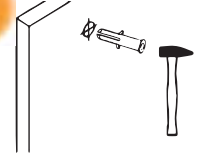

e

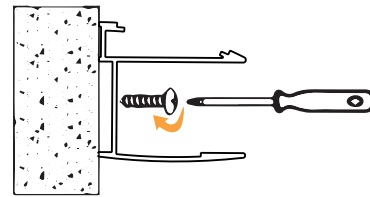

2

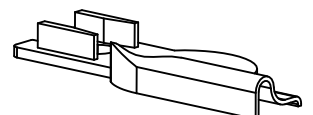
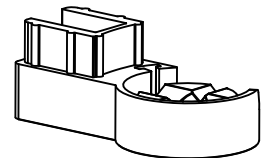
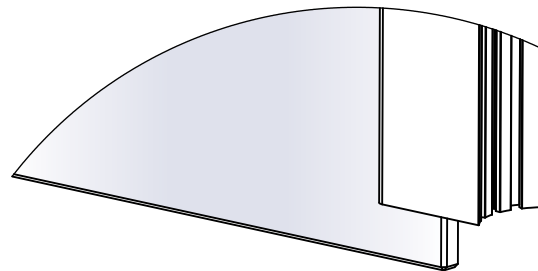
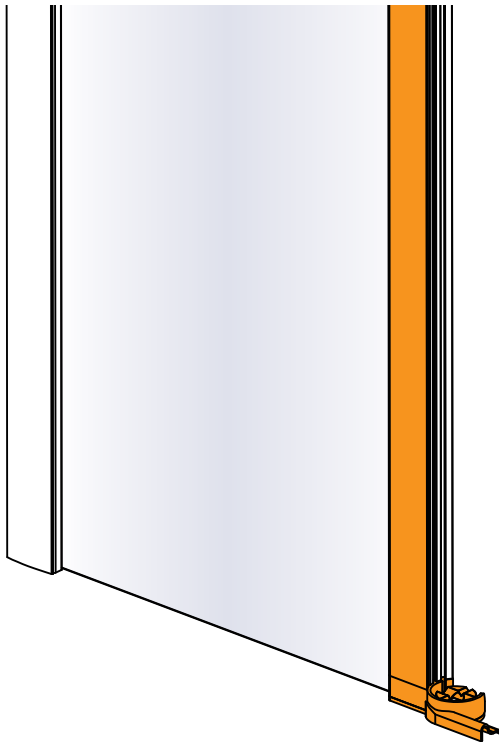

2

3

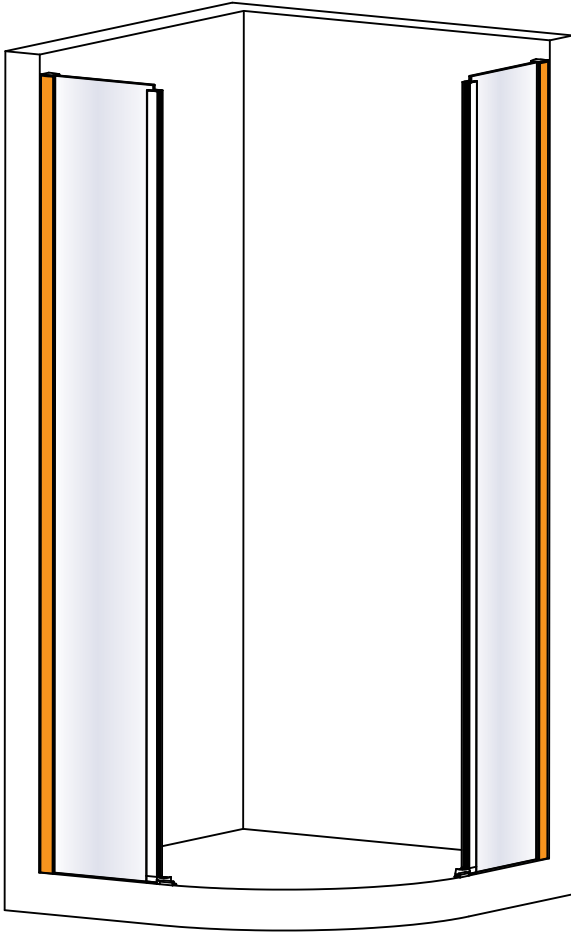

a

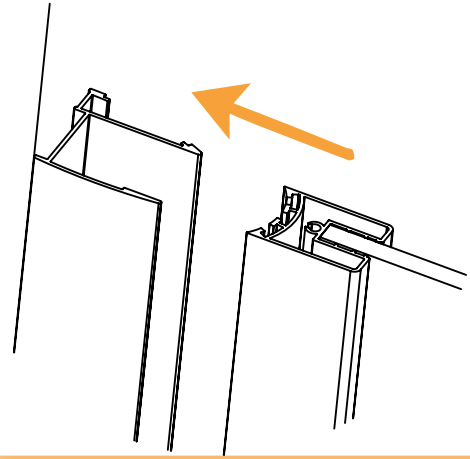

b

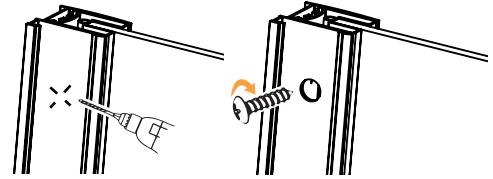

c

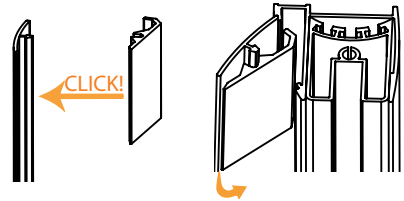

4

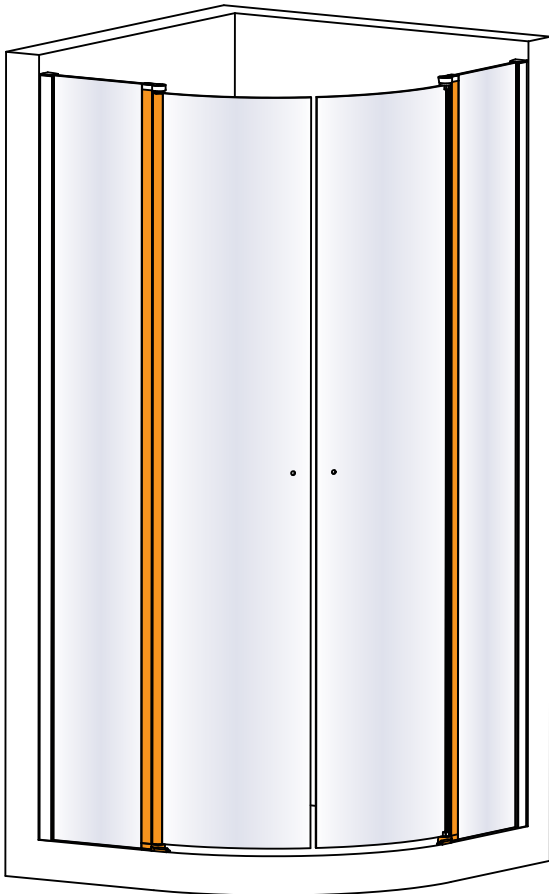

a

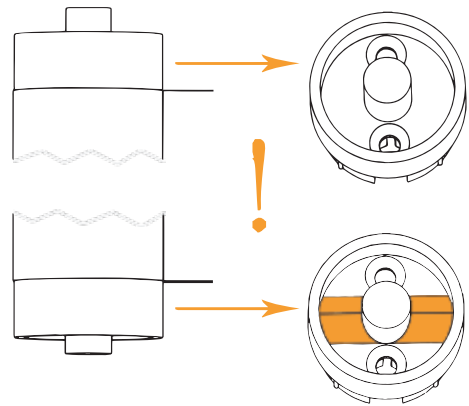

b

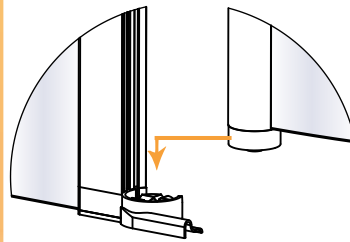

c

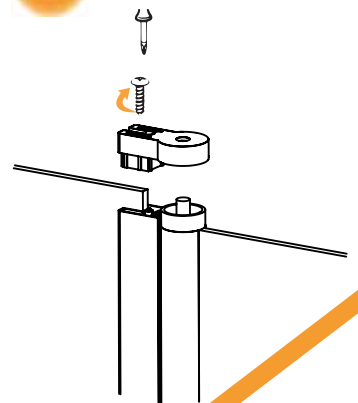

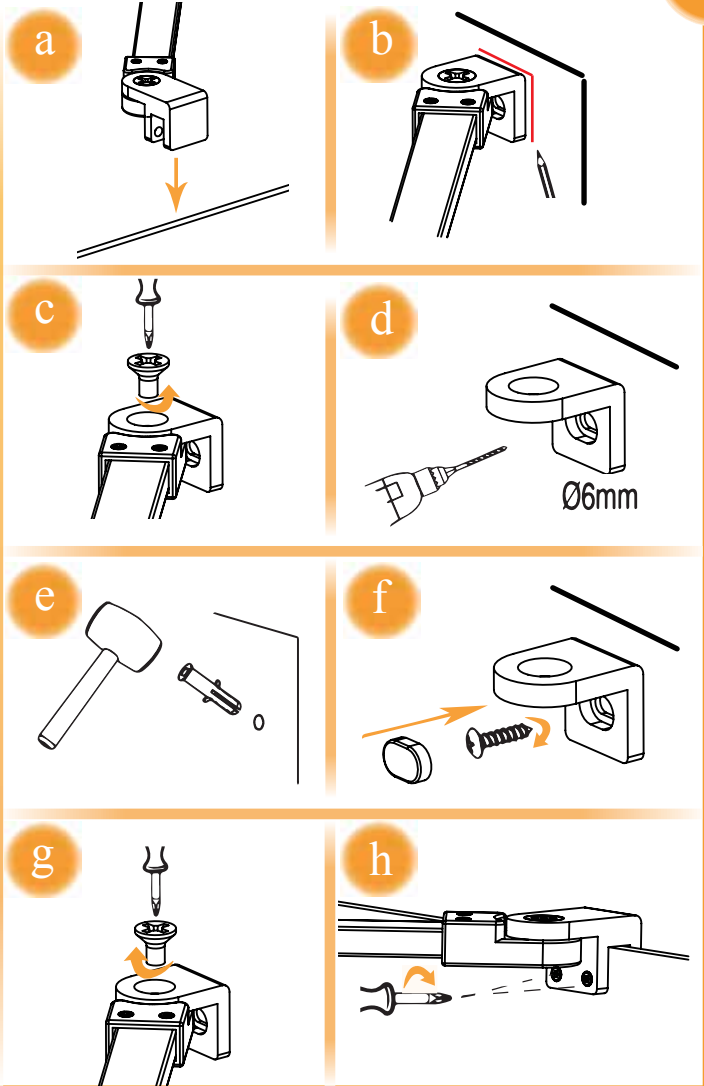
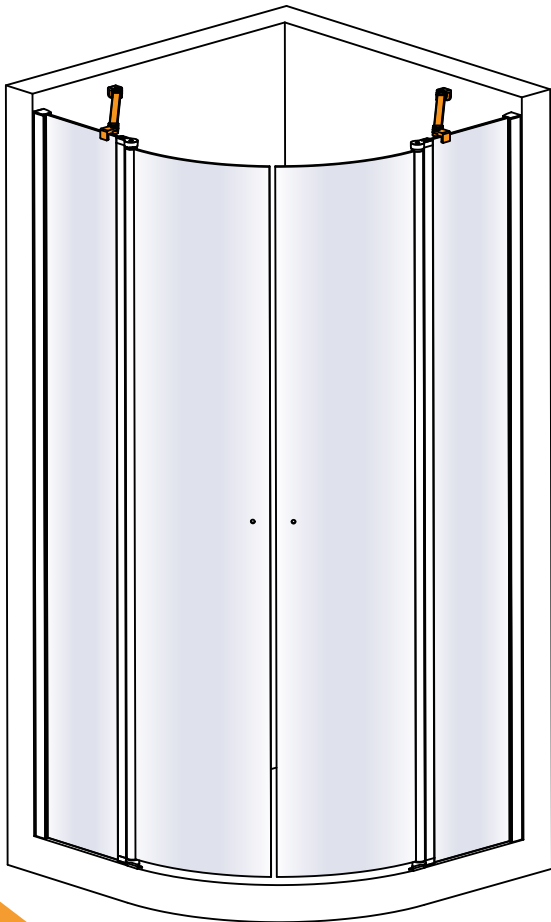
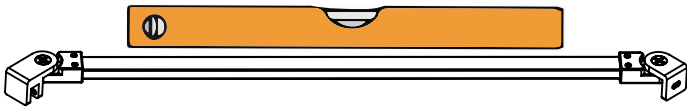
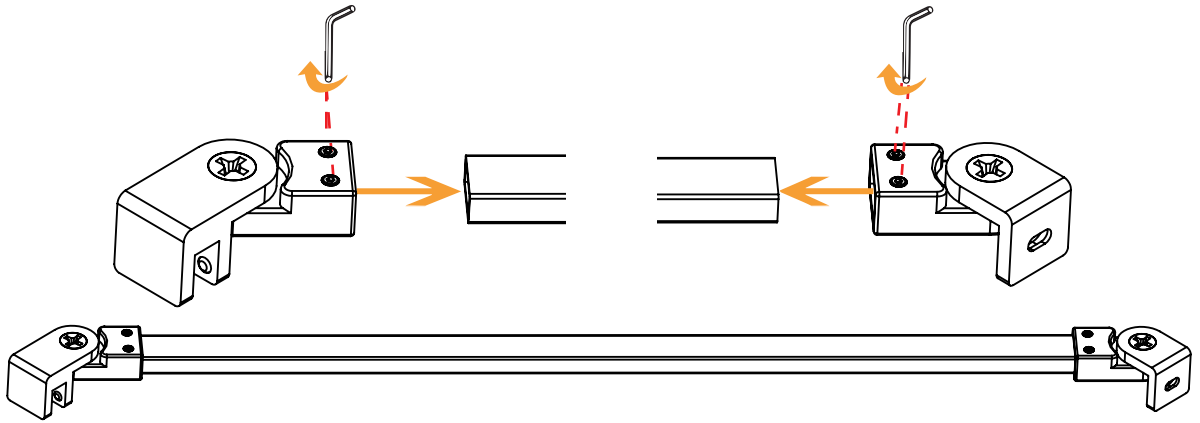
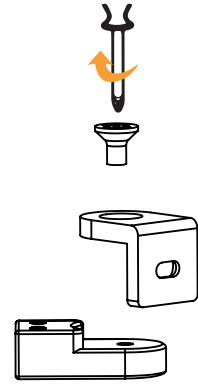
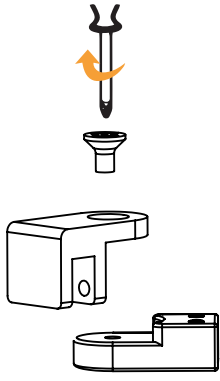

7

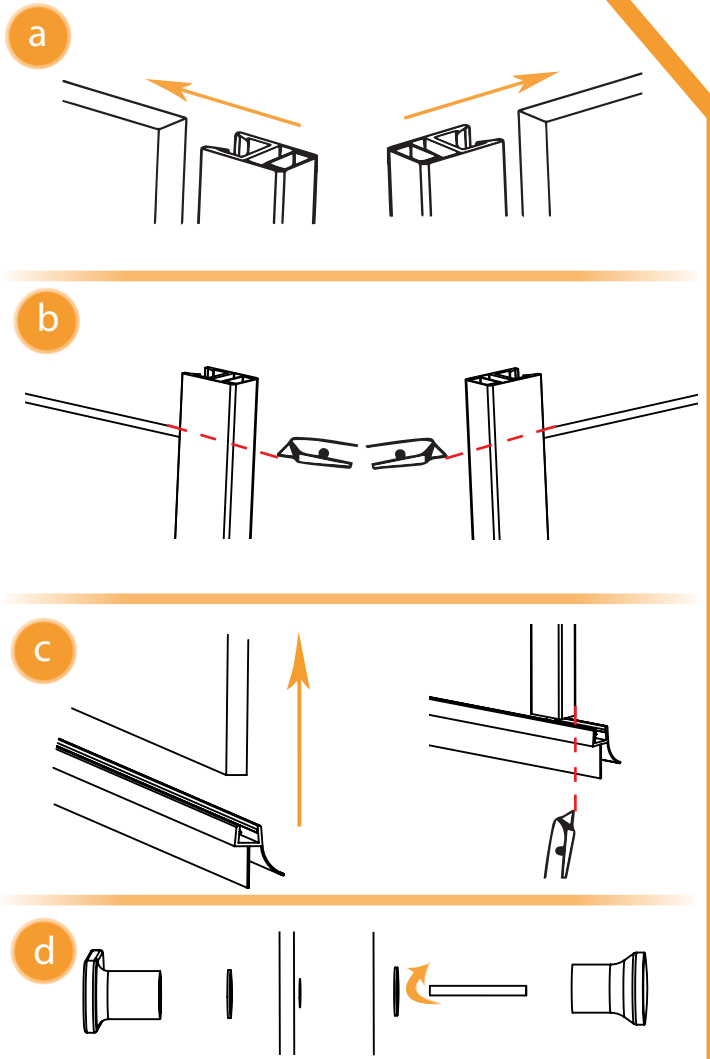
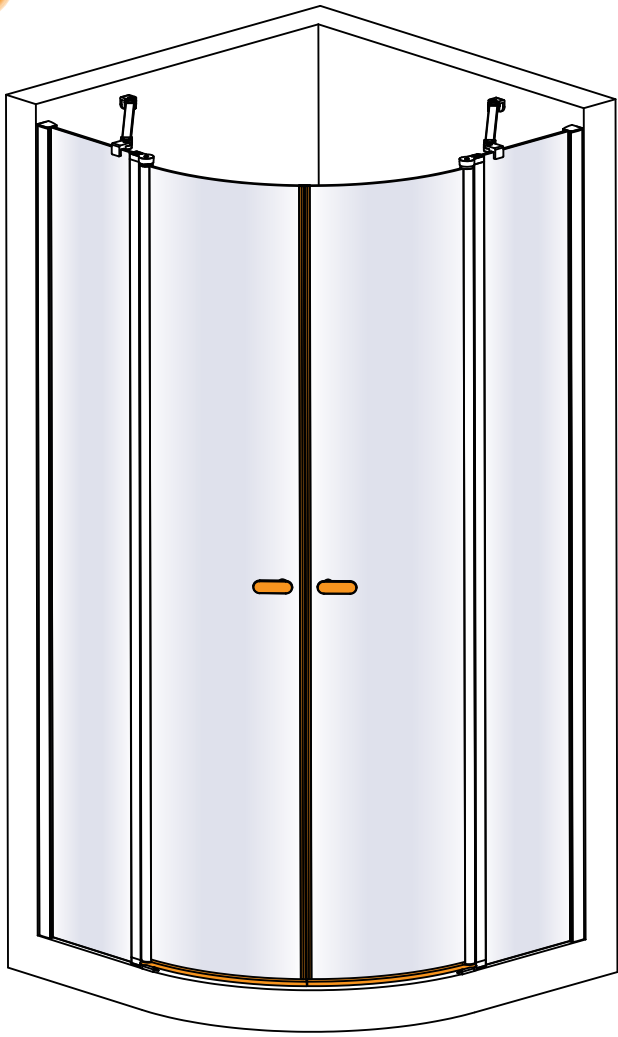

8

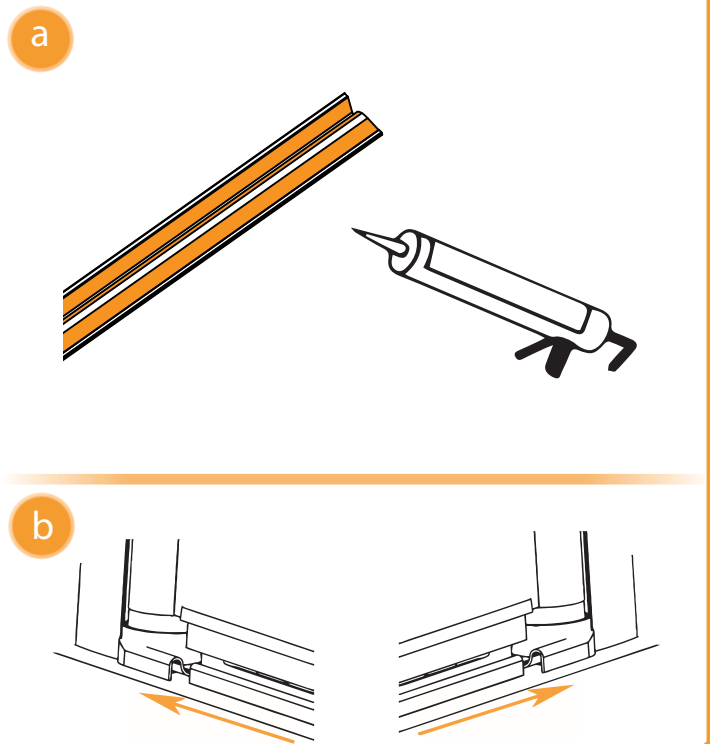
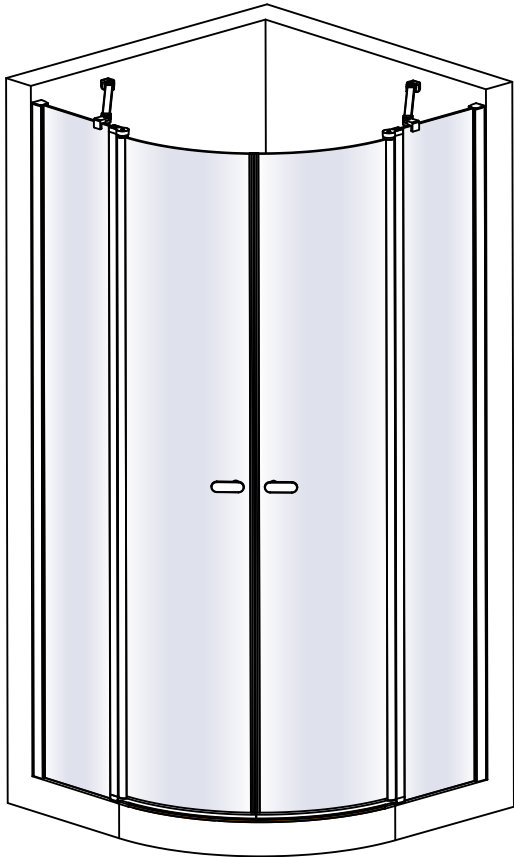

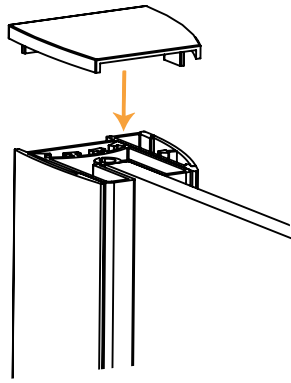

24H

