

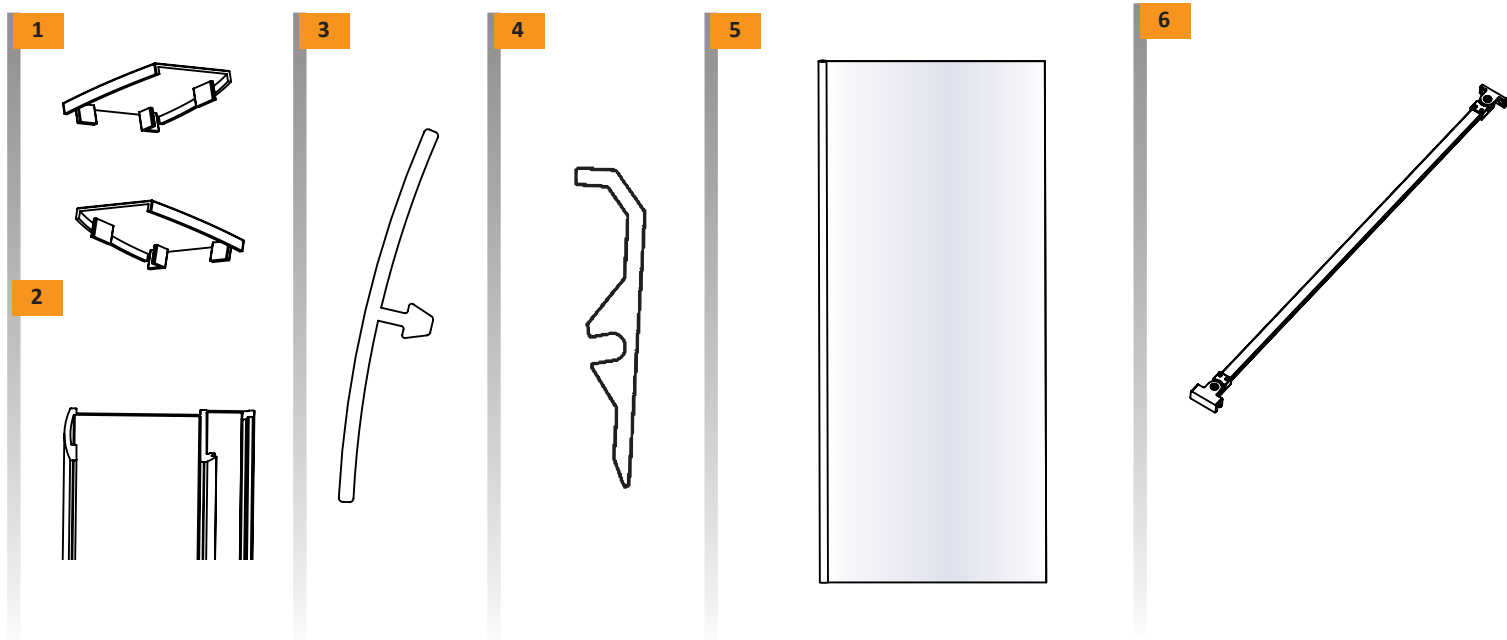

NEW MODUS

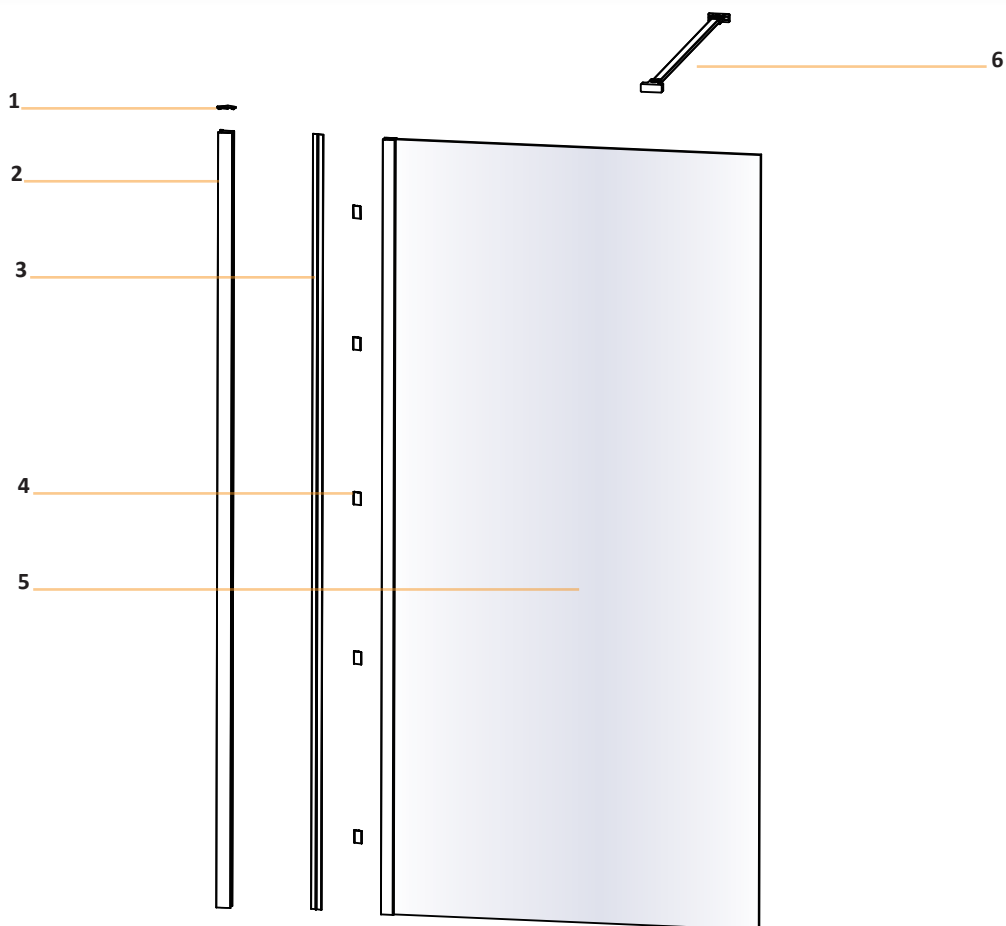

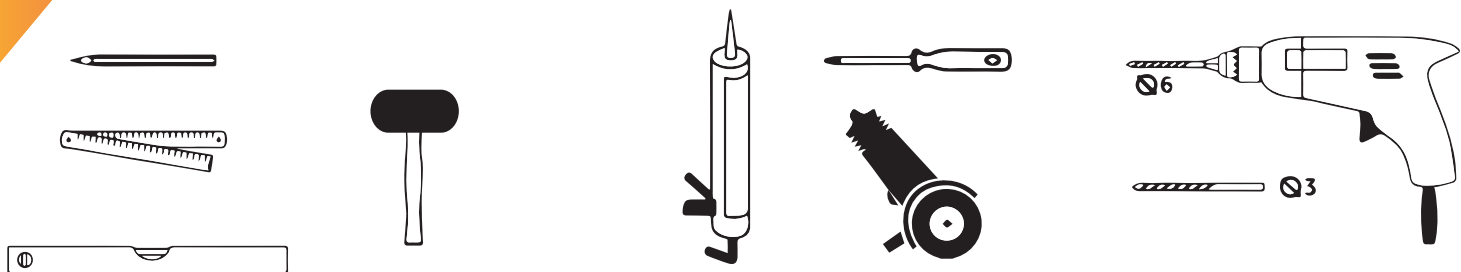

1

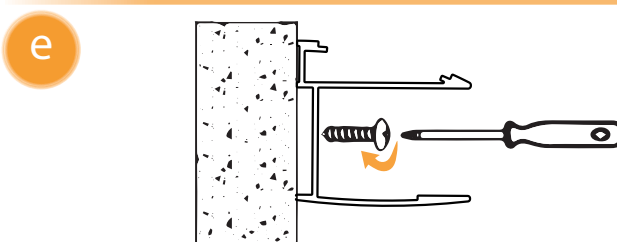
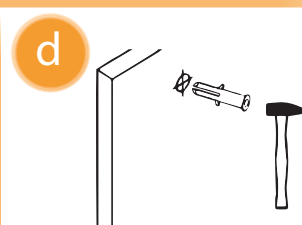
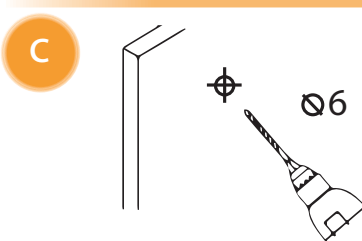
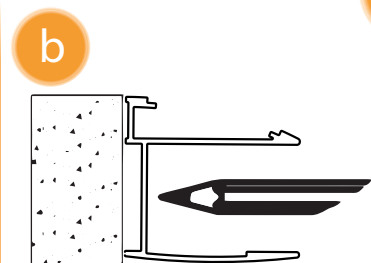
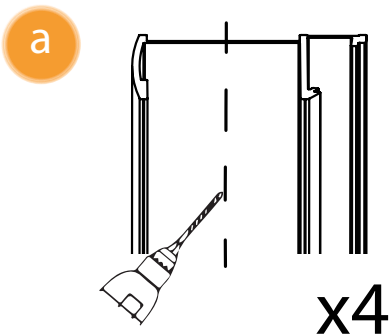
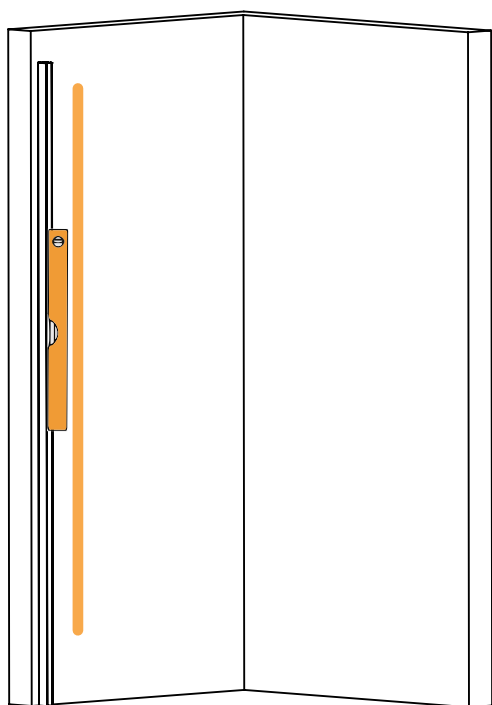

2

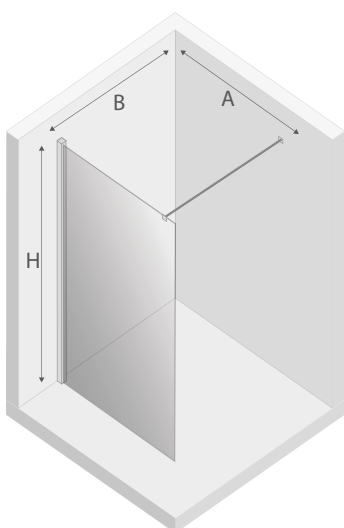

		A	B	H
EXK-0008	70x200	67,5-69	max 120	200
EXK-0009	80x200	77,5-79	max 120	200
EXK-0010	90x200	87,5-89	max 120	200
EXK-0011	100x200	97,5-99	max 120	200
EXK-0012	110x200	107,5-109	max 120	200
EXK-0013	120x200	117,5-119	max 120	200
EXK-0014	130x200	127,5-129	max 120	200
EXK-0015	140x200	137,5-139	max 120	200

3

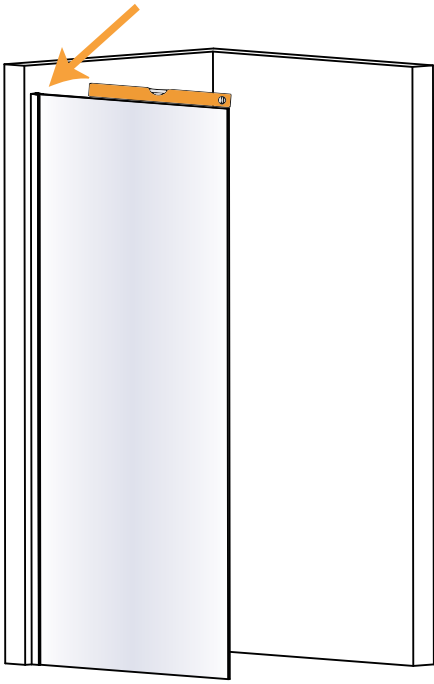

INSIDE

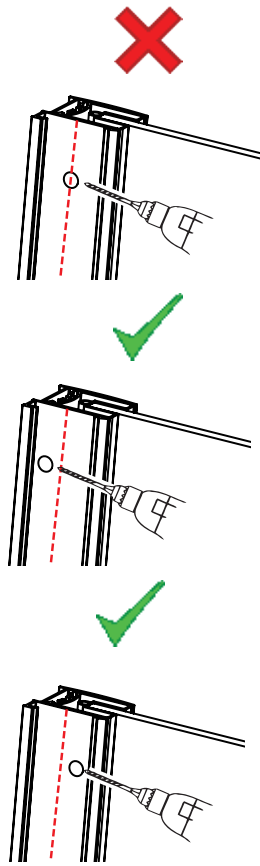

a

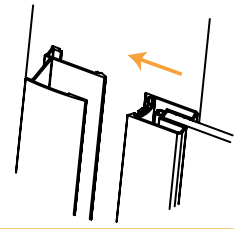

b

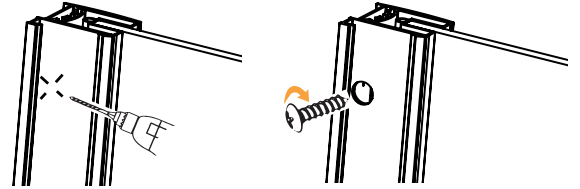

c

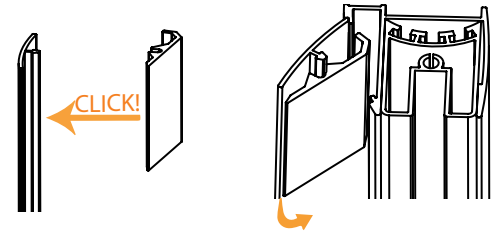

4

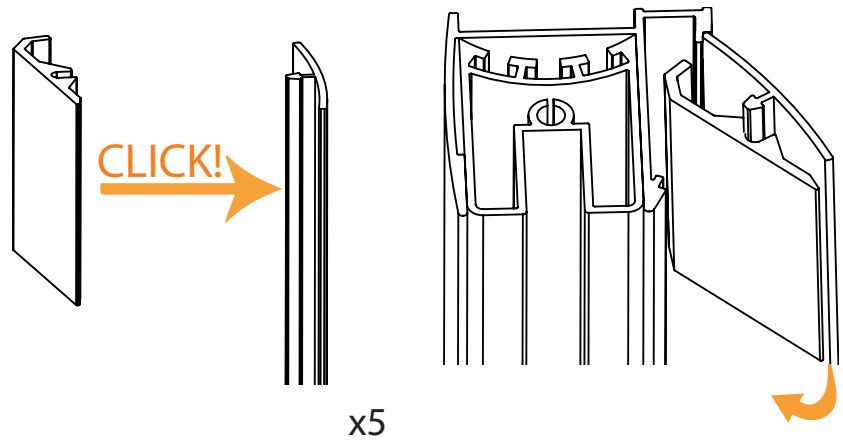
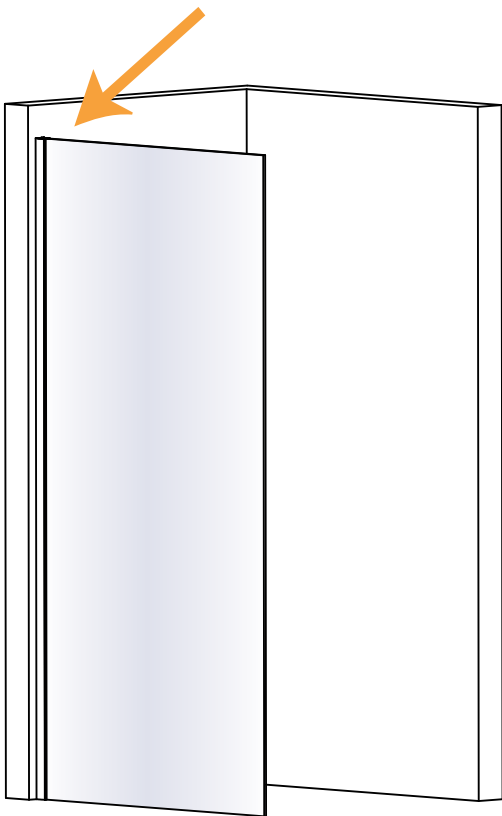

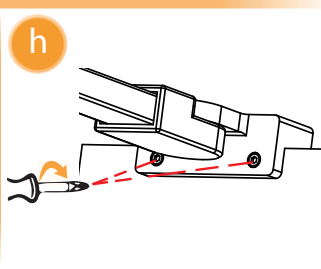
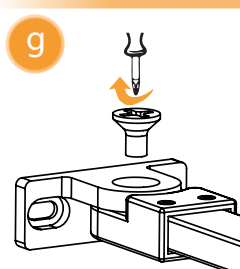
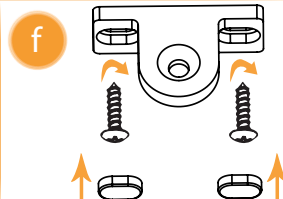
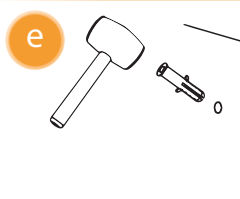
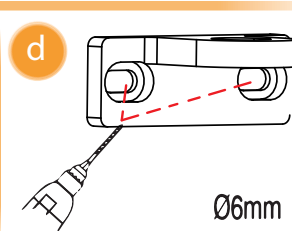
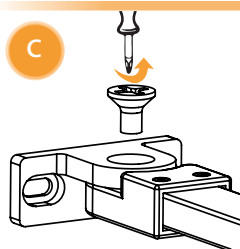
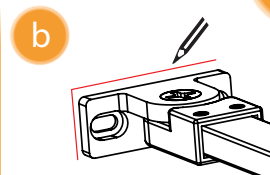
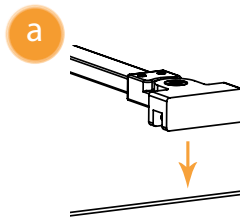
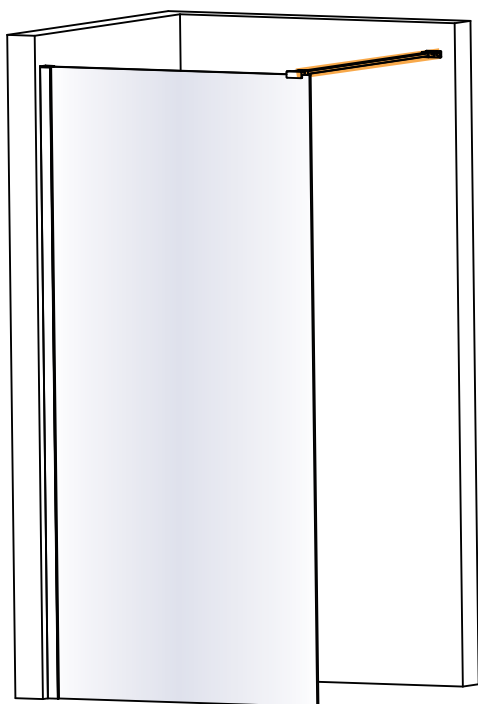
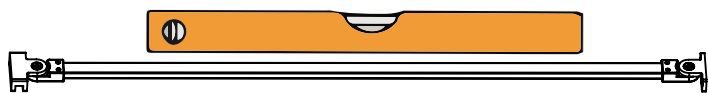
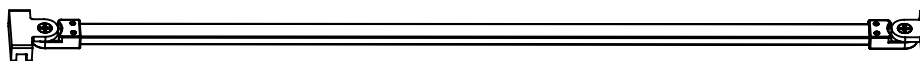
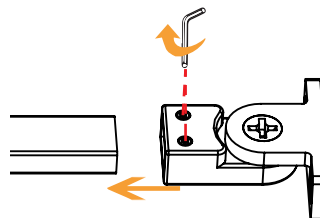
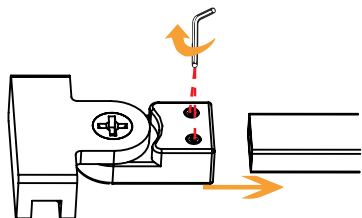
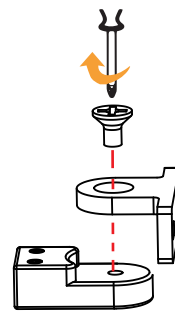
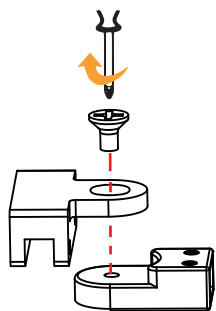
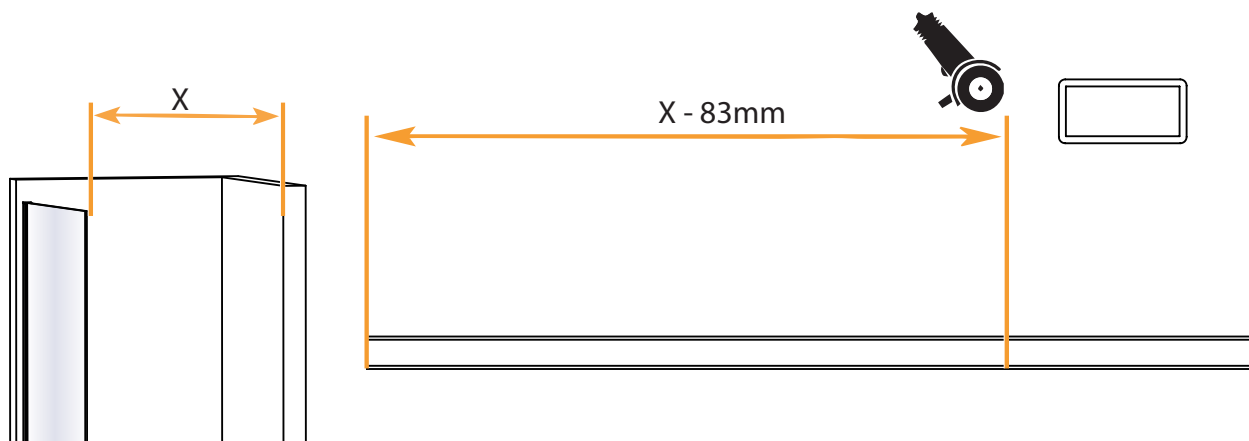

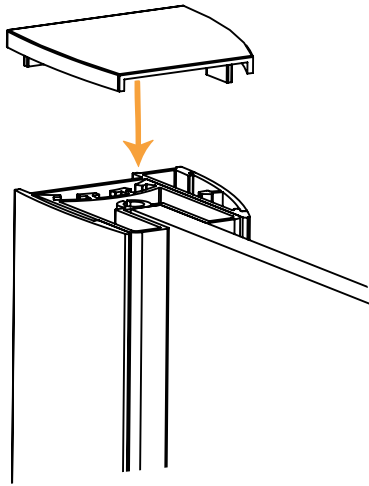

24H

